

## Audison measurement standards

(Power measures taken according to **audison** standard, 1998 edition)

- 12VDC and 13.8VDC;
- 1 kHz or crossover cut-off frequency;
- 0.3% THD @ nominal power; 1% THD @ continuous power;
- Tolerance: +10%; -5%;
- Continuous power given by RMS Voltage measured on resistive load;
- The nominal power of the amplifier is measured upon a battery voltage of 12 Volts with a 4 Ohm load and with all channels in function.

audison

## OWNER'S MANUAL

## CAR POWER AMPLIFIER

**LR<sup>600</sup><sub>X5</sub>**

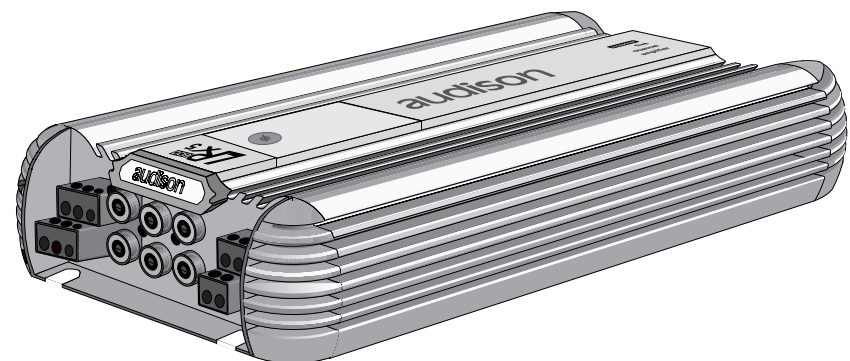

PRINTED IN ITALY - Code 10125780

**audison**  
is a division of **elettromedia**

62018 Potenza Picena (MC) Italy

Tel. 0733.870870 • Fax 0733.870880 • <http://www.audison.com> • e-mail: [com@audison.com](mailto:com@audison.com)

## INTRODUCTION

---

---

### INTRODUCTION

**Audison** thanks you for preferring this product and compliments you on your choice since it was designed in order to insure outstanding musical and instrumental performances.

Before use instructions, please carefully read the safety norms you have to respect in order to avoid unpleasant inconveniences and to enjoy this product at best.

### PRECAUTIONS

- Avoid to install the amplifier where temperature is below 0°C or above 55°C and in non ventilated places.
- The amplifier needs 12VDC power supply voltage with negative to ground. Be sure that your car electric system is compatible with the amplifier ordinary functioning.
- For safer driving, we recommend to adjust volume not to drown external traffic sounds.

### WARNING!:

**While installing the amplifier, make sure that the cable coming from the battery positive pole (+) doesn't touch the amplifier heat sink.**

The heat sink is directly connected to the battery negative pole (-) through the screws which fix it to the vehicle chassis. Its contact with the positive pole cable would cause short circuit and, thus, possible fires and battery damages.

**Please connect power supply cables to the amplifier terminal blocks (POWER + and -) before and to battery AFTER, to get maximum safety..**

### CAUTIONS

**INPUTS:** If the source output signal ground (PRE OUT) is not connected to the source chassis and the system sound is not powerful enough or is distorted, try to solve the problem by connecting the output signal cable braided shield (PRE OUT) to a point of the source chassis.

**OUTPUTS:** Don't connect -L and -R power outputs to each other or to ground (car chassis). In case you use an external crossover, make sure that channels grounds are not connected one to the other.

audison cable PRODUCTS FOR ELECTRIC CONNECTIONS



**MAINCRIMP**



**audison cable**

*RECOMMENDED POWER SUPPLY CABLES*

*Cable must be chosen according to its length and to the system total power.*

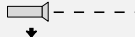

*RING TERMINALS* 

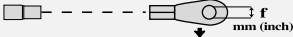
POWER SUPPLY TERMINAL BLOCKS		CABLES		BATTERY + AND GROUND	
					
4 Ohms	MAINCRIMP 8	For 8 A.W.G.	MAINPOWER 8 (red and black)	PR 62.19 R&B	RB 6.45.1G f = 6 (.24) RB 8.45.1G f = 8 (.31)
2 Ohms	MAINCRIMP 8	For 6 A.W.G.	MAINPOWER 5 (red and black)	PR 80.24 R&B	RB 6.58.1G f = 6 (.24) RB 8.58.1G f = 8 (.34)

**RECOMMENDED SPEAKERS CABLES**

SPEAKERS TERMINAL BLOCKS	CABLE
	
MAINCRIMP 14	2x91/40 (4x14 A.W.G.) + 1x93/20 (1x14 A.W.G.)
MAINCRIMP 14	4x93/20 (2x14 A.W.G.) + 1x92/20 (1x12 A.W.G.)

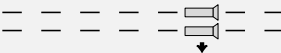
**RECOMMENDED SIGNAL CABLES**

*BEST series PIN-RCA / PIN-RCA extensions are available in the following sizes*

	BS 50 cm 50 (19.68 inch)	BS 300 cm 300 (118.11 inch)
	BS 100 cm 100 (39.37 inch)	BS 400 cm 400 (157.48 inch)
	BS 150 cm 150 (59.05 inch)	BS 450 cm 450 (177.16 inch)
	BS 200 cm 200 (78.74 inch)	BS 500 cm 500 (196.85 inch)
		BS 600 cm 600 (236.22 inch)

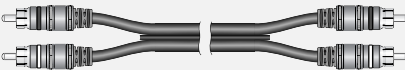
**Description** ..... p. 4

**In-Out panel**

Functions ..... 5

**Power supply panel**

Functions ..... 6

Fuse replacement ..... 7

**Controls panel**

Functions and controls ..... 8

**Setting panel**

Functions ..... 10

Amplifier configuration ..... 10

Subsonic filter cut-off frequency modification ..... 11

VCA-VCA1D modules insertion ..... 11

**Technical features**

Size for fixing ..... 12

LRx 5.600 ..... 12

**Accessories**

VCR01K, VCRAK and VCRDK ..... 13

CLK2 - LRx Cooling Kit ..... 14

**Configurations**

Block diagram ..... 16

Configurations table ..... 17

Controls panel diagram and configuration switches ..... 17

**Configuration examples**

Front+Rear+Sub (F-R Mode) ..... 18

Multichannel+Sub ..... 18

3 Channel Front+Rear ..... 19

**Installation**

Logo rotation ..... 20

Amplifier fixing ..... 21

Electric connections ..... 21

**audison cable products for electric connections** ..... 22

**audison measurement standards** ..... 24

## DESCRIPTION

### Audison LRx 5.600:

Five channel car power amplifier characterised by excellent musical performances, small size and outstanding energy reserve.

Its PWM power supply stage is made with two pairs of 70A MOSFETs; it is stabilised and oversized. Input stage is provided with a special circuit (LNS) which allows the system disturbances rejection, reducing noise that is usually due to the vehicle electric parts (alternator, electronic injection, etc.), without altering musical signal quality.

Driver stages are characterised by a very linear circuitry. They have coupled differential transistors and an A Class complementary voltage amplifier. Power sections have Darlington configuration with high gain and SOA (Safety Operation Area) BJT TO247. Thanks to its great capacity to supply current, to the use of a pair of BJT for every channel and of two pairs for the sub, this amplifier can easily drive even the hardest loads and satisfy whatever power needs. It can give 60W on Front and Rear channels and 180W on sub with 4 Ohm load, 85W on Front and Rear channels and 240W on sub at 2 Ohms in continuous mode. Power increases up to 170Wx2 at 4 Ohms and to 240Wx1 at 2 Ohms in mono configuration (3-Ch). Differently from what occurs with other amplifiers, LRx 5.600 is not blocked by protection systems immediately below these load values. Its exclusive "Overload Limiter" circuit allows it to go on working, limiting output power and pointing out how hard the applied load is by the "Limit" LED blinking.

Its big power reserve, its constant control at low frequencies and its exquisite timbre qualities make it an ideal amplifier to realise systems designed to attain outstanding musical features and very high sound pressures (SPL).

LRx 5.600 has a bypass subsonic filter (24dB/Oct.) with adjustable frequency, pre-set at 20Hz, and three Butterworth crossovers with independent frequencies: HI/LO-PASS (12dB/Oct.), HI-PASS (12dB/Oct.) and LO-PASS (24dB/Oct.). Constant Bass function is also available; it permits to control the subwoofer level whatever the head unit Fader adjustment is.

Four switches under the setting panel in the amplifier bottom allow to choose:

- functioning configuration: Front/Rear and Multichannel;
- 3/5 channel output;
- the activation of a third input dedicated to subwoofer.

They also permit to configure the preamplified output (OUT) as additional input to accept the source output for Rear system.

In case LRx amplifiers are used in extremely difficult conditions (very low loads) or in installations where space is too narrow and their heat sink cooling is not enough, they can be employed together with CLK2 cooling system (optional). It is a system made of two units to apply onto the amplifier sides; each of them is provided with an electronically controlled fan that allows the amplifier thermal stabilisation (see "CLK2 - LRx Cooling Kit").

Protection includes:

- **RGP** (Resettable Ground Protection) circuit; in case a short circuit occurs between loudspeakers outputs and car chassis, it detects a high current flow in the pre-input ground and acts by putting the amplifier in stand-by, protecting its circuitry;
- a device against short circuits and against DC in the outputs, to protect loudspeakers.
- a device that detects the amplifier temperature excessive increase and stops its functioning until optimal conditions occur again.

Once the causes which implied protection circuits intervention have been checked and solved, the amplifier is reset by switching it off and on again.

The amplifier is also provided with another general protection which is insured by an internal strip fuse, very easy to reach.

### Optional:

The following devices are available upon request:

- 1 - Three kits for subwoofer volume remote control:
  - VCR01 and VCRAK (analogue and specific for subwoofer);
  - VCRDK (digital; it can be used for master volume control or for level control of any ways in a multichannel system).
- 2 - CLK2 cooling system.

## INSTALLATION

### AMPLIFIER FIXING

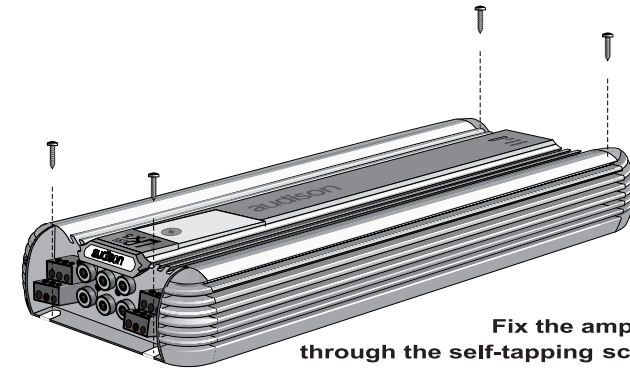

Fix the amplifier through the self-tapping screws (4.2 x 16) given with it.

### ELECTRIC CONNECTIONS

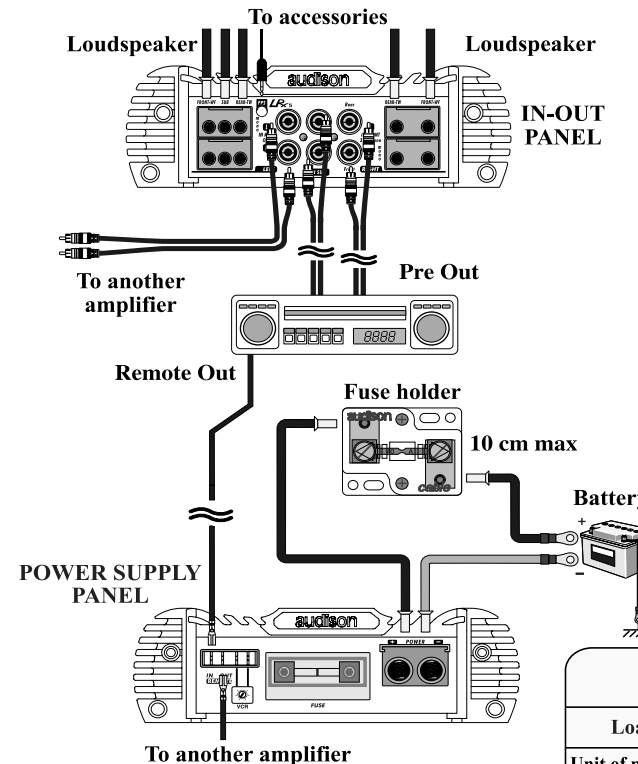

### CAUTION!

For the system safer protection, we recommend the use of a strip fuse on the cable that connects the battery positive pole to the amplifier POWER (+) terminal block. This fuse has to be installed about 10 cm far from the battery; its value will have to be equal or slightly higher (+10% approx.) than consumption @13.8 VDC, according to the different configurations (see "Technical features").

It will have to be equal to the sum of the values of all fuses in case system consists of several amplifiers or in case amplifiers have several fuses.

**LRx 5.600 FUSE: 50A**

POWER SUPPLY CABLE SIZE Length: 4/5 m				
Load	4 Ohms		2 Ohms	
Unit of measure	mm <sup>2</sup>	A.W.G.	mm <sup>2</sup>	A.W.G.
<b>LRx 5.600</b>	8.3	8	12.3	6

## LOGO ROTATION

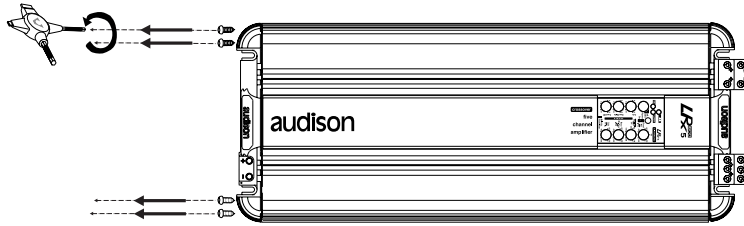

**1** - Remove the transparent cover which protects controls and then the 4 screws which block the metal plate by using multispanner.

**2** - Remove the plate without damaging the silkscreen printed panel which will have to stay on. We suggest that you seize both plate grips with your hands and pull them by blocking the silkscreen printed panel with your fingers against the amplifier chassis at the same time. This will permit to remove the plate from the panel without damages.

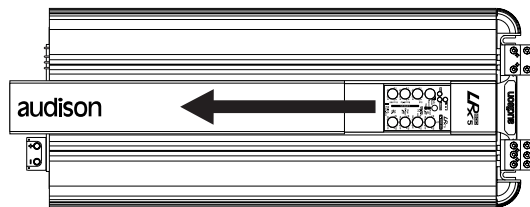
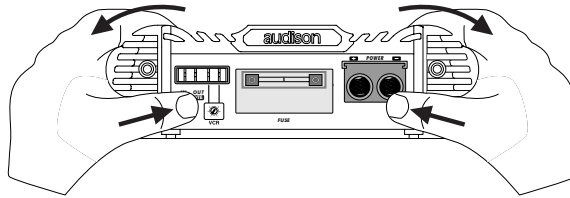

**3** - Remove the strip with audison logo.

**4** - Put the strip back again after turning it, so that audison logo is upside down.

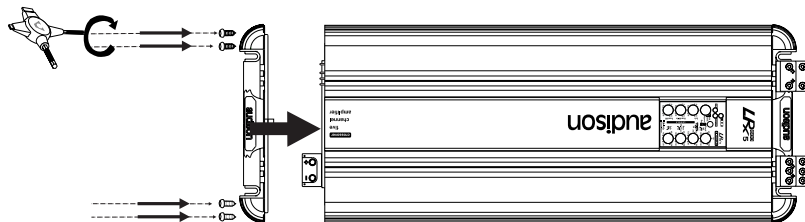
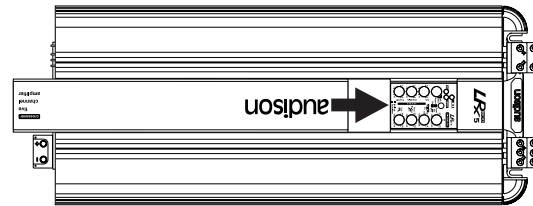

**5** - Mount the plate back by fixing it through the screws; then, re-assemble the transparent cover which protects controls.

## FUNCTIONS

**1**

### FRONT-WF/REAR-TW/SUB

Power outputs of the amplifier Front, Rear and Sub channels. Connect the speakers cables to these outputs according to polarity. Terminal blocks accept cables up to 9 A.W.G. max (see "audison cable products for electric connections" as far as their size is concerned). We recommend the use of audison cable products. Please use FRONT-WF channels +L and -R terminal blocks called **mono** for the right channel (R) and REAR-TW channels +L and -R terminal blocks for the left channel (L) in order to connect the amplifier in mono (3 Ch.) and to exploit the maximum power insured by this configuration.

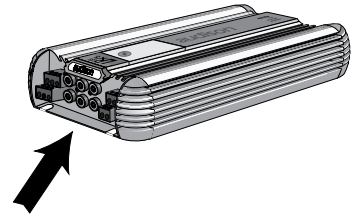

**2**

**PPS (Phantom Power Supply)**  
Power supply socket for audison external audio accessories.

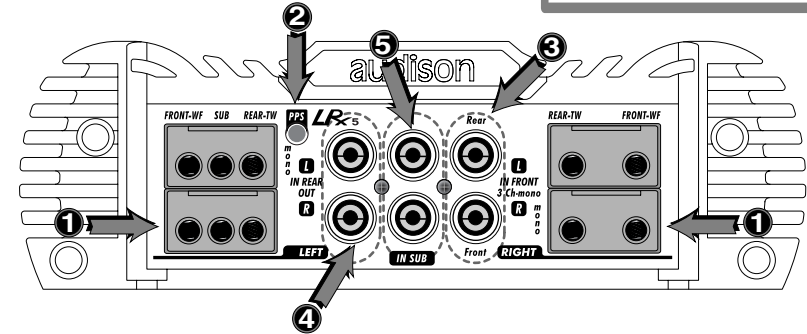

**3**

### IN FRONT / 3 Ch-mono

Left (L) and right (R) channels inputs of the amplifier Front system. Front preamplified outputs of a source (head unit, CD player, DAT, etc.) or of an external electronic crossover must be connected to them. In three channel configuration (3 ch), the right channel (R) drives **Front** outputs in mono, while the left channel (L) drives **Rear** ones in mono. The subwoofer can be driven by these two inputs together; if the source has the necessary, special output, it can be driven through **In Sub** input, to select through the proper switch.

**4**

### IN REAR/OUT

Left (L) and right (R) channels inputs of the amplifier REAR system. Rear preamplified outputs of a source (head unit, CD player, DAT, etc.) or of an external electronic crossover must be connected to them. These inputs can also be configured as amplifier HI-PASS preamplified outputs (see "Configurations table").

**5**

### IN SUB

Left (L) and right (R) channels inputs. They accept the possible subwoofer preamplified output coming from the source. Since subwoofer output is mono, the two inputs are to be mixed when used together.

FUNCTIONS

**1**

**REMOTE IN**  
Terminal to connect Remote cable, which comes from the source and which controls the amplifier switching on. Applied voltage must be between 7 and 15VDC.

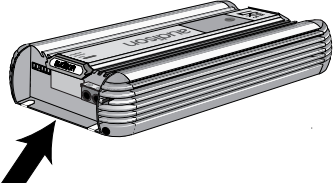
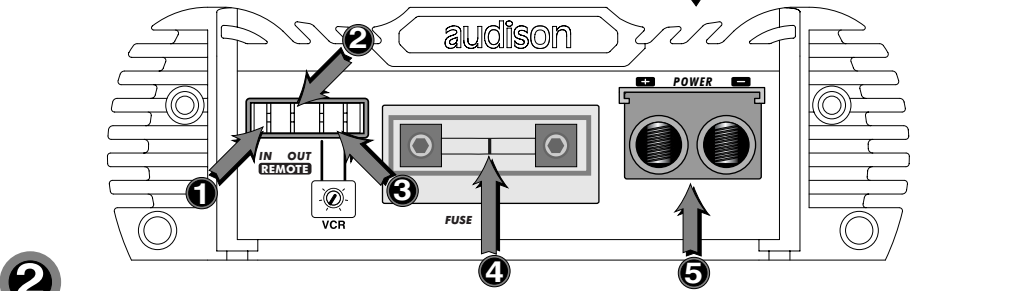
**2**

**REMOTE OUT**  
Terminal to repeat the switching on control (Remote IN) coming from the source. It is used to switch on another amplifier or device in the system simultaneously. Available voltage is the same as the one applied on Remote IN.

**3**

**VCR (optional kit)**  
Terminals to connect VCR01/VCRA/VCRD adjuster included in sub output volume remote control kits (VCR01K/VCRAK/VCRDK).

**4**

**FUSE (50A)**  
Strip fuse. It insures the amplifier general protection. In case the fuse breaks down, please replace it by respecting its original value.  
CAUTION: If you want to protect the system even more, please put a strip fuse onto the cable which connects the battery positive pole to the amplifier POWER (+) terminal block (see "Electric connections").

**5**

**POWER**  
Terminal blocks for the amplifier power supply cable connection. Connect positive and negative poles according to indicated polarities. Holes have 8mm diameter and accept cables up to 3 A.W.G. max. In order to get the best current transfer, please use power supply cables with as big a section as possible. **audison cable** catalogue offers you a complete range of such products which can satisfy whatever demands; you can also find **Maincrimp** terminals in it. We strongly recommend their use because they contain the cable non protected end and allow the terminal block to fasten all its useful section.

3 CHANNEL FRONT+REAR

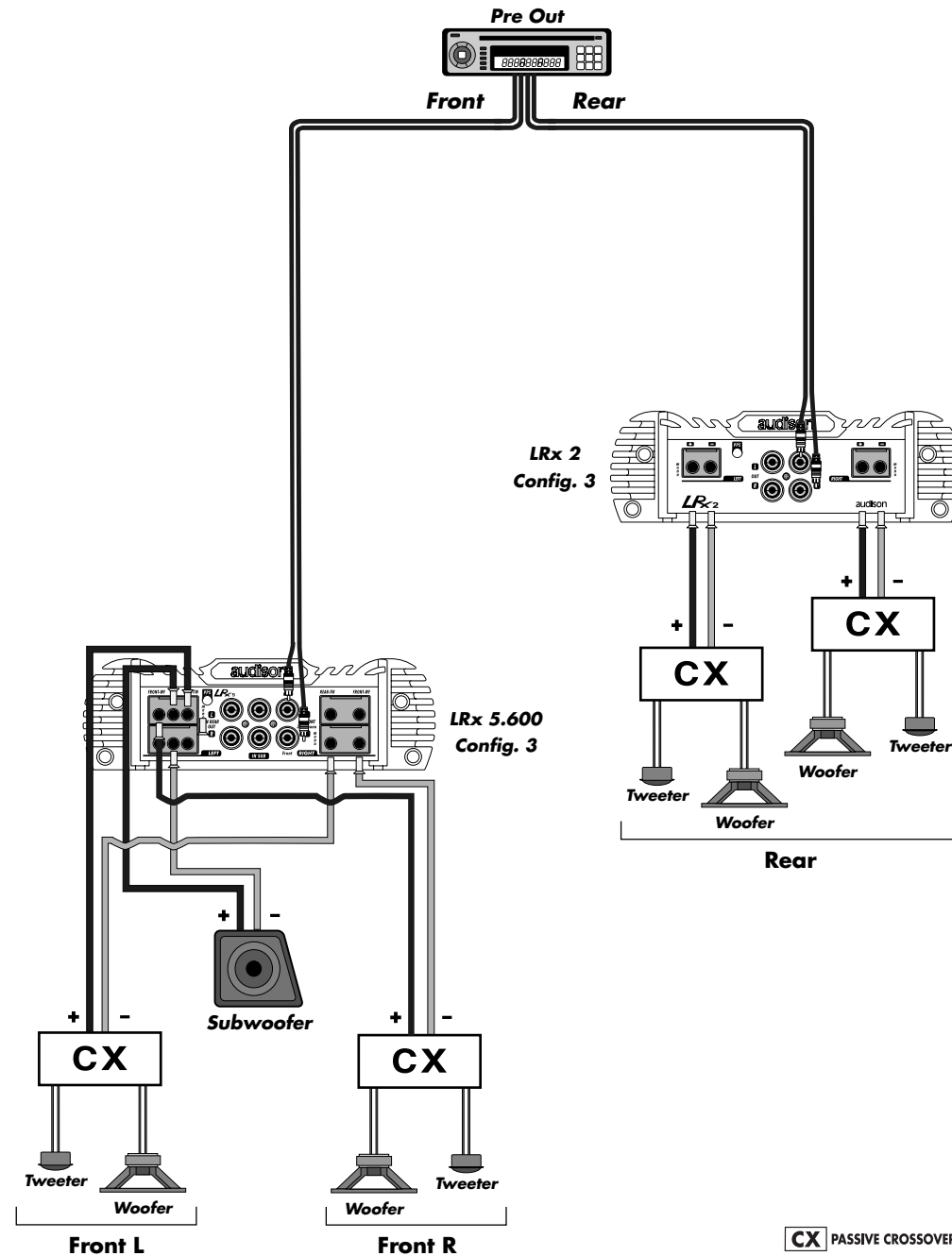

FRONT+REAR+SUB (F-R MODE)

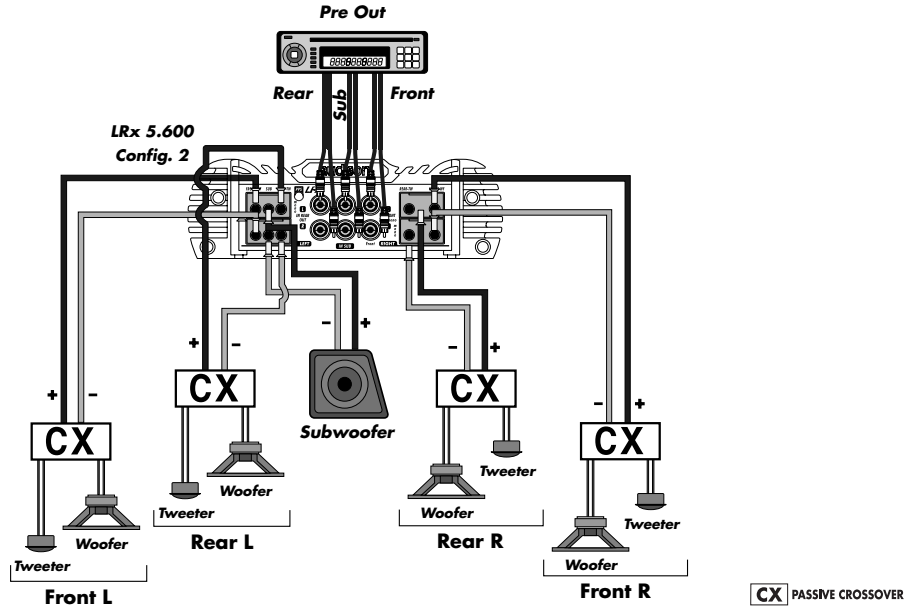

MULTICHANNEL+SUB

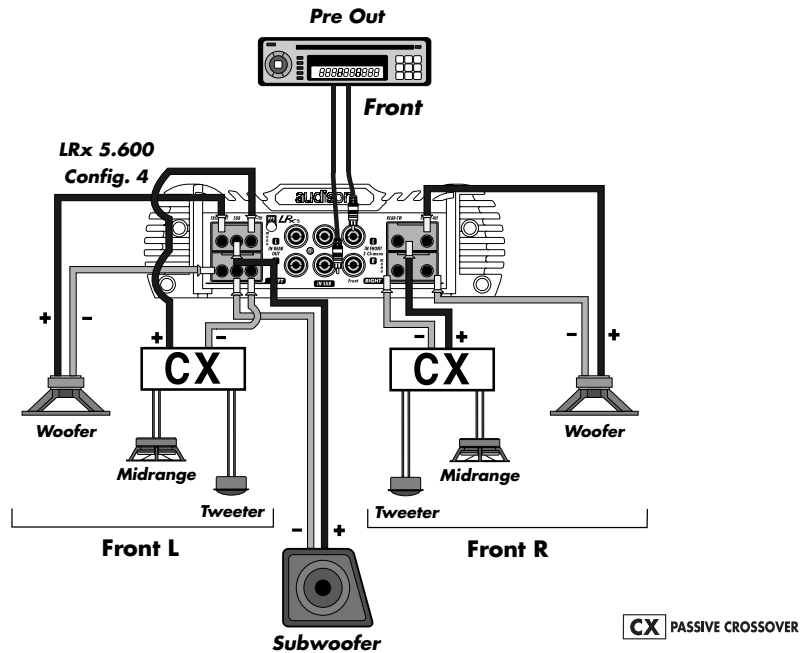

FUSE REPLACEMENT

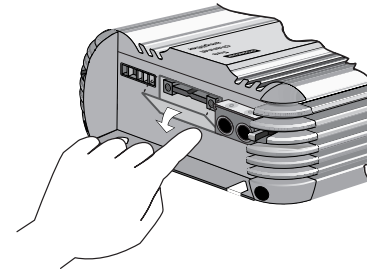

1 - Open the transparent cover by pushing the two teeth in its lowest corners to the direction indicated by the arrows.

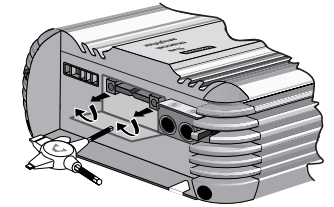

2 - Remove the screws which fasten the fuse to eliminate pieces of the broken one; prevent them from going into the device.

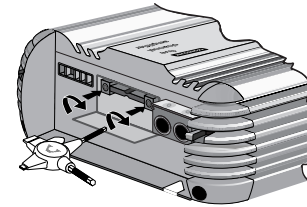

3 - Check the value of the new fuse to assemble, then fix it by gradually and alternately fastening the two screws. This will avoid voltage drops along the line and will make the device perfect functioning easier.

4 - Close the transparent cover.

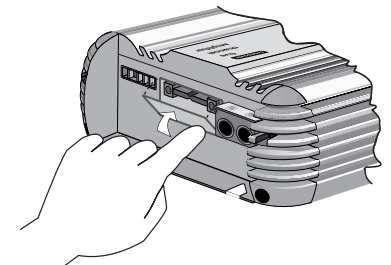

FUNCTIONS AND CONTROLS

1

**LIMIT (orange LED)**

It indicates the Overload Limiter circuit is on.

**Caution:**

When this led is on (although sporadically), it means the applied load is a hard one. The activation of Overload Limiter circuit (output power limiter) will anyway allow the amplifier to function without distortions. In case Overload Limiter gets on too frequently (at every power peak), you will need to check if there are any failures or a too hard load (that's to say impedance is about 50% lower than the minimum recommended one). The amplifier can go on functioning in these conditions but power will inevitably decrease.

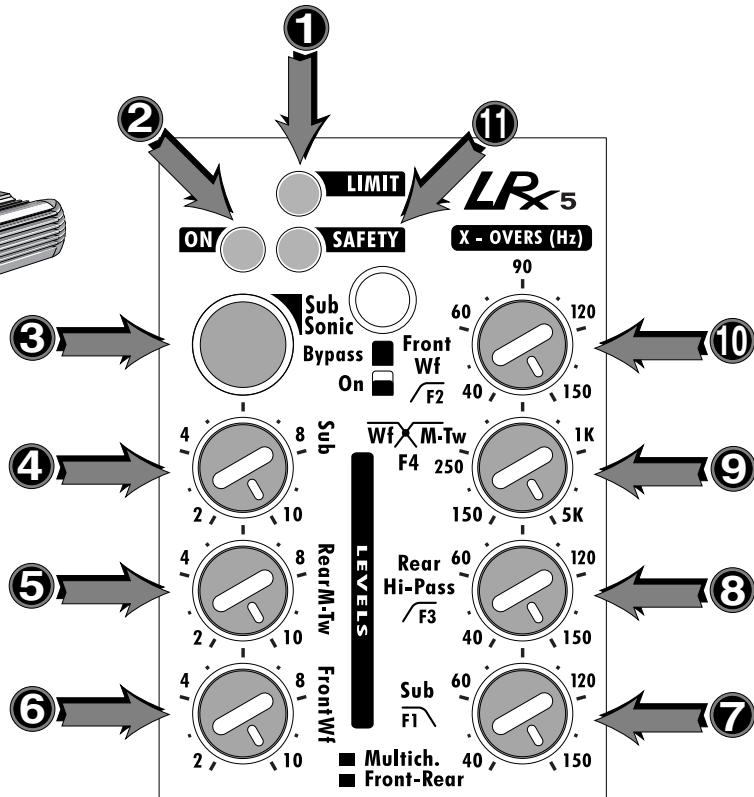
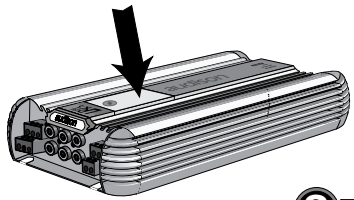

2

**ON (green LED)**

It indicates the amplifier is on.

CONFIGURATIONS TABLE

LRx 5.600 can be configured as follows:

**Config. 1 = 5 Ch.: Front** (Hi 12dB) + **Rear** (Hi 12dB) + **Sub** (Lo 24dB); IN Front (1 IN); Input Sub (IN Sub/IN Front)

**Config. 2 = 5 Ch.: Front** (Hi 12 dB) + **Rear** (Hi 12dB) + **Sub** (Lo 24dB); IN Front/Rear (2 IN); Input Sub (IN Sub/IN Front + Rear)

**Config. 3 = 3 Ch.: Front L + R** (Hi 12dB) + **Sub** (Lo 24dB); IN Front (1 IN); Input Sub (IN Sub/IN Front + Rear)

**Config. 4 = 5 Ch. Multichannel: Woofer** (Hi/Lo 12dB) + **Tweeter** (Hi 12dB) + **Sub** (Lo 24dB); IN Front (1 IN); Pre Out: (Hi 12dB)

**Config. 5 = 3 Ch. Multichannel: Woofer L + R** (Hi/Lo 12dB) + **Sub** (Lo 24dB); IN Front (1 IN); Pre Out: (Hi 12dB)

CONFIG.	FRONT/WF	REAR/TWEETER	SUB	IN-REAR PRE-OUT	IN-SELECT	MIXED SUB* IN-SUB	MODE	CH SELECT	PRE IN
1	12dB F2	12dB F3	24dB F1	NOT USED	1 IN	FR SUB	FR MC	5 CH	1IN/SUB
2	12dB F2	12dB F3	24dB F1	IN REAR	2 IN	FR SUB	FR MC	5 CH	2IN/SUB
3	BRIDGED 12dB F2 (RIGHT)	BRIDGED 12dB F2 (LEFT)	24dB F1	NOT USED	NOT USED	FR SUB	FR MC	3 CH	1IN/SUB
4	12dB F2 F4	12dB F4	24dB F1	12dB F3	1 IN	FR SUB	FR MC	5 CH	1IN/SUB
5	BRIDGED 12dB F2 (RIGHT) F4	BRIDGED 12dB F2 (LEFT) F4	24dB F1	12dB F3	1 IN	FR SUB	FR MC	3 CH	1IN/SUB

\* MIXED SUB (F+R)/IN SUB switch can be set as follows:  
 - MIXED SUB (F+R): sub is driven by Front and Rear signals together  
 - IN SUB: sub is driven by the special input.

CONTROLS PANEL DIAGRAM AND CONFIGURATION SWITCHES

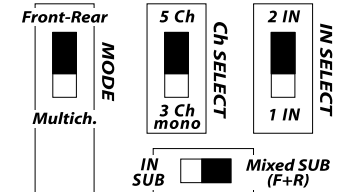
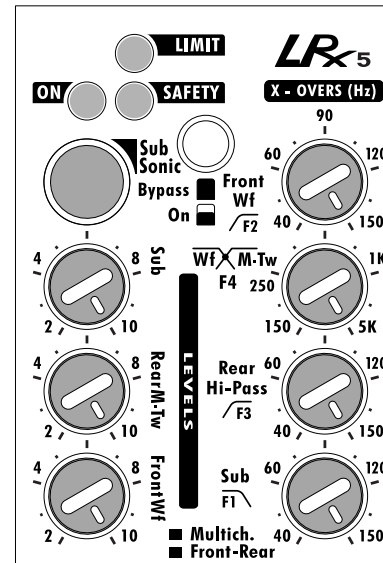



BLOCK DIAGRAM

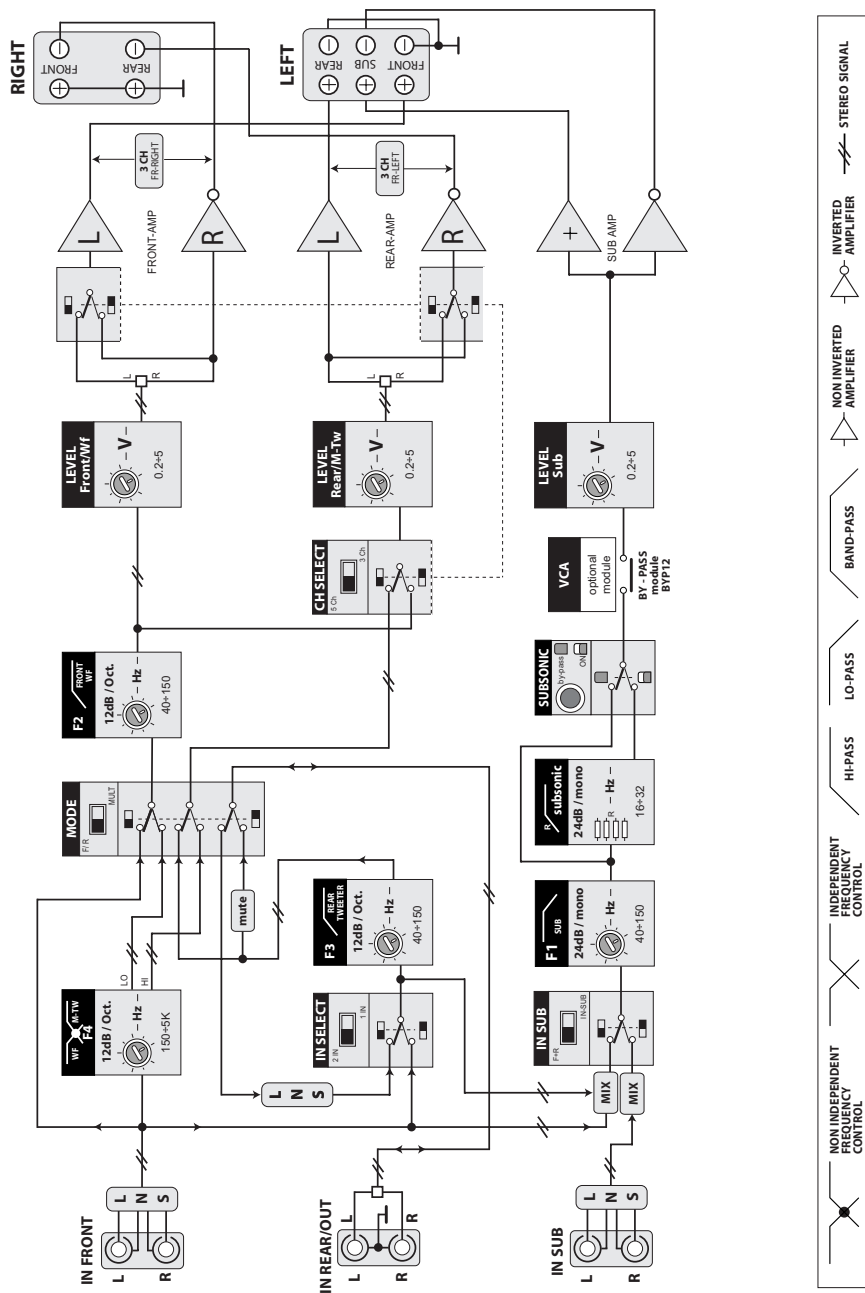

3

**SUBSONIC**

It permits to eliminate subsonic frequencies; these sounds cannot be heard by human ears but cause useless and damaging stress to amplifier and speakers.

Subsonic filter can be bypassed (**BYPASS**) and it is pre-set at **20 Hz**. Its cut-off frequency can be adjusted between 16 and 32 Hz through 4 Hz steps; this occurs by replacing the special resistors located into a socket which can be reached through the setting panel in the amplifier bottom.

4

**SUB (Level)**

It adjusts the amplifier Sub channel input sensitivity and sets its output level.

5

**REAR M-TW (Level)**

It adjusts the amplifier Rear channels input sensitivity and sets its output level. In multichannel configuration, the adjustment concerns the channels for the high frequencies HI-PASS filter (M-Tw).

6

**FRONT WF (Level)**

It adjusts the amplifier Front channels input sensitivity and sets its output level. In multichannel configuration, the adjustment concerns the channels for the woofer BAND-PASS filter (Wf).

7

**F1**

It permits to adjust the subwoofer 24dB/Oct. LO-PASS filter cut-off frequency between 40 Hz and 150 Hz.

8

**F3**

It permits to adjust the Rear system 12dB/Oct. HI-PASS filter cut-off frequency between 40 Hz and 150 Hz. It works only in Front-Rear configuration.

9

**F4**

It permits to adjust the woofer 12dB/Oct. LO-PASS filter and the Mid-Tweeter 12dB/Oct. HI-PASS filter crossover frequencies between 150 Hz and 5 kHz. It works only in Multichannel configuration.

10

**F2**

It permits to adjust the 12dB/Oct. HI-PASS filter cut-off frequency between 40 and 150 Hz; this filter is for woofer in Multichannel configurations and for Front system in Front-Rear configurations.

11

**SAFETY (red LED)**

It indicates that the amplifier protection circuits are on. In order for the amplifier to work again, you need to switch the system off and then on after 10 seconds at least. We recommend to check all connections before switching the amplifier on again.

**If LED stays on, please contact Audison authorised after sale centres.**

FUNCTIONS

It permits to reach the switches for the amplifier configuration, the resistors to set subsonic filter cut-off frequency and to insert VCA modules for the subwoofer volume remote control.

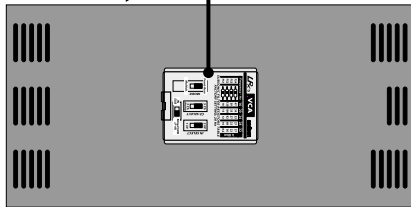
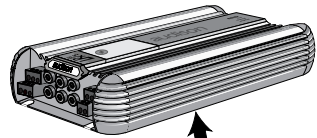

Setting panel

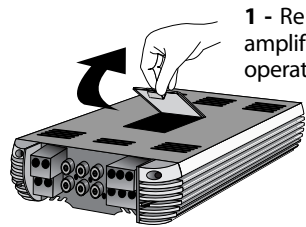
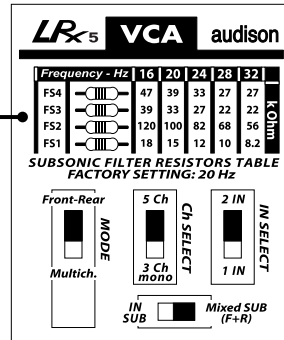

1 - Remove the setting panel in the amplifier bottom in order to carry out operations.

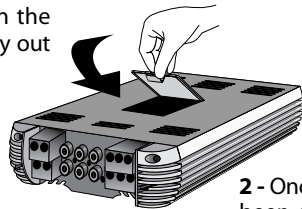

2 - Once operations have been carried out, please close the setting panel.

AMPLIFIER CONFIGURATION

LRx 5.600 is configured through **IN SELECT**, **Ch. SELECT**, **MODE** and **IN SUB/MIXED SUB (F+R)** switches, located under the setting panel.

• **IN SELECT (1 IN - 2 IN)**

It permits to use OUT preamplified output as additional input for the head unit Rear preamplified output, if available (2 IN). This configuration also activates Constant Bass function.

If this switch is on 1 IN, you will be able to make a Front+Rear+Sub system by using only the Front input.

• **Ch. SELECT (5 Ch. - 3 Ch. mono)**

It configures the amplifier output as 3 or 5 channels. If switch is on 5 Ch., you will be able to make a Front+Rear+Sub system; if it is on 3 Ch. mono, you will be able to have a Front+Sub system.

• **MODE**

It permits to choose the amplifier functioning configuration between Front-Rear and Multichannel. If switch is on Front-Rear, Hi-Pass filters for Front (F2) and Rear (F3) system are activated. If it is on Multich., Hi-Pass filters for Woofer (F2) and for Woofer/Mid-Tweeter (F4) are activated.

• **IN SUB/MIXED SUB (F+R)**

It activates IN SUB input to accept the source third preamplified output for subwoofer (IN SUB).

In case source doesn't have it, it is possible to drive the subwoofer by taking the necessary signal from IN Front and IN Rear inputs (MIXED SUB F+R).

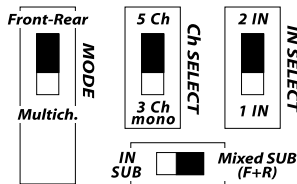

Installation:

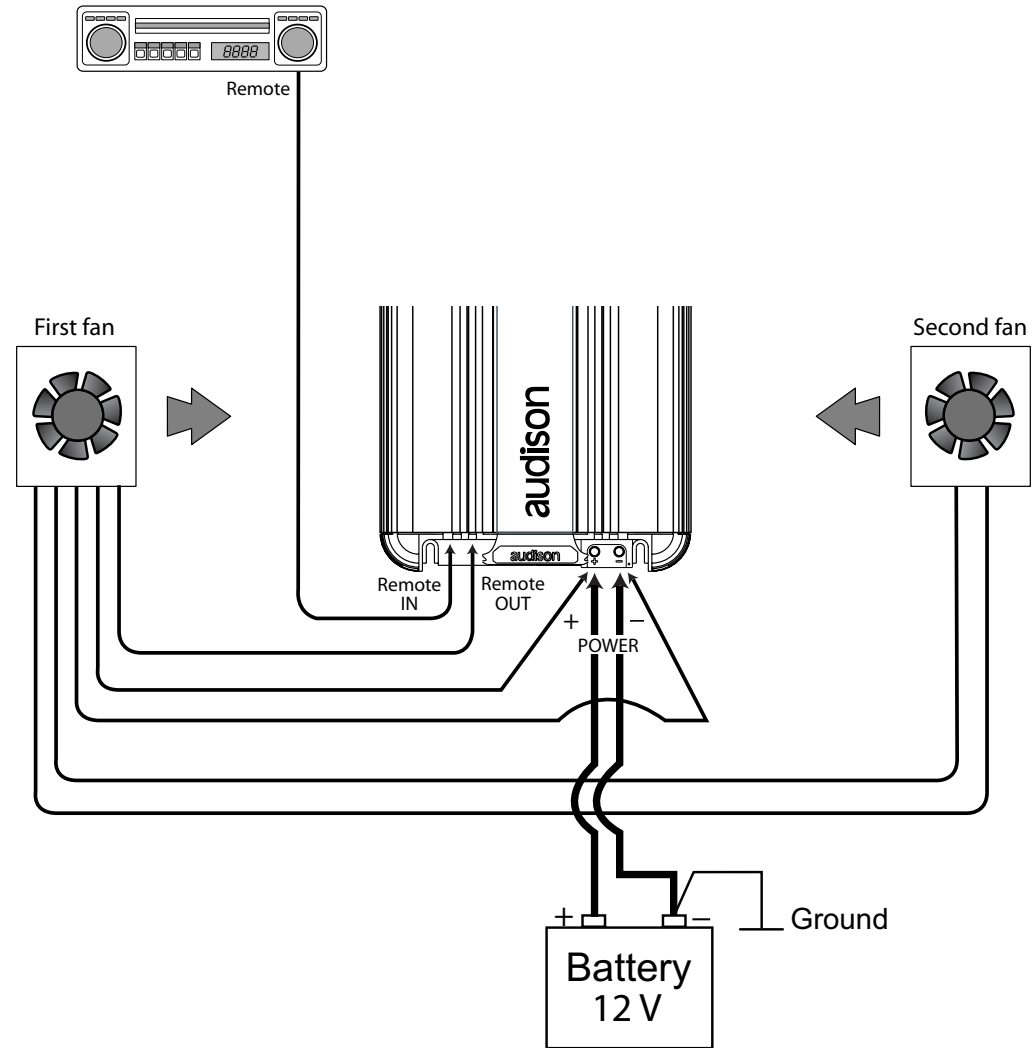

**CLK2 - LRx Cooling Kit**

This cooling system is specially designed to provide LRx amplifiers with the right working temperature.

**CLK2** should be used when LRx amplifiers work in extremely hard conditions (very low loads) or in installations where space is too narrow and heat sink cooling is not enough. It consists of two units to apply onto the amplifier sides; each of them is provided with an electronically controlled fan. Its intervention depends on a thermal sensor that starts the system as soon as LRx heat sink reaches 45°C. The same sensor is connected to a special circuit which controls the two fans speed progressive increase when temperature increases, too.

Air flux constant control allows the amplifier very good thermal stabilization and limits noise.

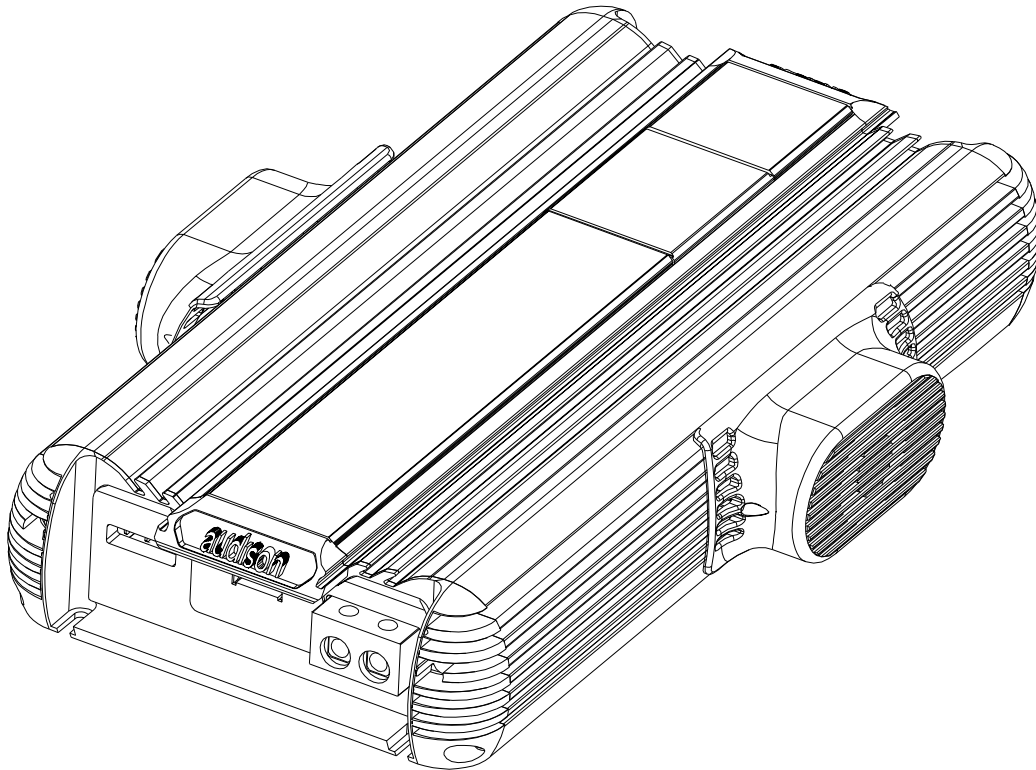

**SUBSONIC FILTER CUT-OFF FREQUENCY MODIFICATION**

Subsonic filter is pre-adjusted at 20 Hz. In order to modify this value, please act according to what follows.

**Procedure:**

**LRx5 VCA audison**

Frequency - Hz	16	20	24	28	32	kOhm
FS4		39	33	27	27	
FS3		33	27	22	22	
FS2		100	82	68	56	
FS1		15	12	10	8.2	

**SUBSONIC FILTER RESISTORS TABLE**  
FACTORY SETTING: 20 Hz

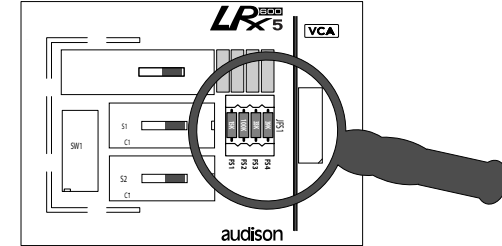

Replace FS1, FS2, FS3, FS4 resistors according to the values in the setting panel table.

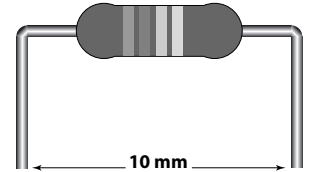

**Remark:** Cut the new resistors rheophores according to the size in the picture.

**VCA-VCA1D MODULES INSERTION**

LRx 5.600 can accept one of the three optional kits which allow the subwoofer volume remote control: VCR01K, VCRAK or VCRDK.

These kits have a specific module, VCA or VCA1D, to insert into the amplifier through the setting panel.

**Installation:**

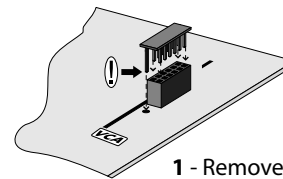

1 - Remove BYP12 bridge.

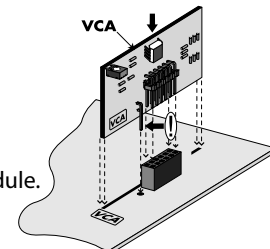

2 - Insert VCA/VCA1D module.

- Insertion key. It prevents the module from being inserted in the wrong way.

## TECHNICAL FEATURES

### SIZE FOR FIXING

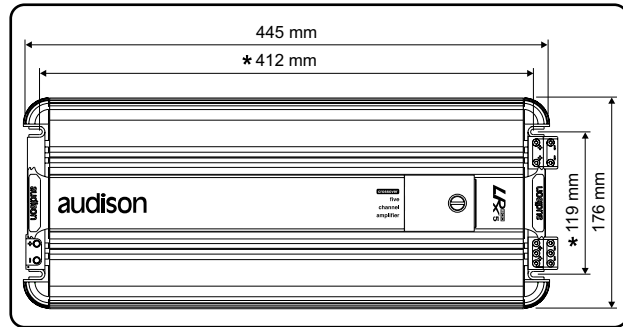

\* Drilling dimensions for fixing

### LRx 5.600

#### POWER SUPPLY

Voltage: ..... 11 ÷ 15 VDC  
 Idling current: ..... 1 A  
 Idling current when off: ..... 0.02 mA

#### Consumption @ 13.8 VDC

(Max Musical Power):  
 - A config. (see Output Power): ..... 33 A  
 - B/C config. (see Output Power): ..... 48.9 A

#### AMPLIFIER STAGE

Distortion – THD (1kHz): ..... 0.009 %  
 Bandwidth (-3dB): ..... 4 Hz ÷ 85 kHz  
 S/N ratio(A weighed @ 1V): ..... 105 dB  
 Damping factor (1 kHz, 4 Ohms): ..... 240  
 Input sensitivity: ..... 0.2 ÷ 5 VRMS  
 Input impedance: ..... 15kOhms

#### Load impedance:

- Front/Rear (4 Ch. stereo): ..... 4-2 Ohms  
 - Front/Rear (2 Ch. mono in bridge): ..... 4 Ohms  
 - Sub: ..... 4 – 2 Ohms

#### Nominal output power (RMS)

**NP** @ 12VDC; THD 0.3%: .....  
 60W x 4 (4 Ohms) + 180W x 1 (4 Ohms)

Output power (RMS) @ 13.8 VDC; THD 1%  
 - A config.: 60W x 4 (4 Ohms) + 180W x 1 (4 Ohms)  
 - B config.: 85W x 4 (2 Ohms) + 240W x 1 (2 Ohms)  
 - C config.(3 Ch): 170W x 2 (4 Ohms) + 240W x 1 (2 Ohms)

#### FILTERS/INPUTS

Front-Rear/Front 3 Ch.:  
 12dB/Oct. Hi-Pass (40 ÷ 150 Hz)  
 Multichannel:  
 - Woofer: 12dB/Oct. Band-Pass  
 (40 ÷ 150 Hz/150 ÷ 5000 Hz)  
 - Mid/Tweeter: 12dB/Oct. Hi-Pass (150 ÷ 5000 Hz)  
 SUB (IN F-R: Constant Bass):  
 24dB/Oct. Lo-Pass (40 ÷ 150 Hz)  
 Subsonic: Bypass/24dB/Oct. Hi-Pass, 16 ÷ 32 Hz  
 (pre-set at 20 Hz)  
 Pre Out (IN Front): 12dB/Oct. Hi-Pass (40 ÷ 150 Hz)  
 Inputs: ..... IN Front - IN Rear (Pre Out) - IN Sub

#### OTHER FUNCTIONS

Remote IN: ..... 7 ÷ 15 VDC – 1 mA  
 Remote OUT: ..... 12 VDC – 10 mA  
 Auxiliary power supply (PPS):. ±12 VDC – 300 mA  
 IN VCR (SUB volume) VCA/VCA1D attenuation: 100 dB  
 Fuse: ..... 50 A

**MAX SIZE** (L x H x D): ..... 176 x 56 x 445 mm  
**WEIGHT:** ..... 3.9 kg

## ACCESSORIES

### VCR01K, VCRAK and VCRDK

LRx 5.600 can accept one of the optional kits that allow the subwoofer volume remote control. VCR01K and VCRAK are analogue and special for sub; VCRDK is digital and can be used for master volume control or for level control of any ways in a multichannel system.

These kits are available as accessories and consist of three elements:

- 1) Volume adjuster (VCR01/VCRA/VCRD);
- 2) VCA/VCA1D module to put inside the amplifiers;
- 3) Wire to connect VCR01/VCRA/VCRD adjusters to the proper sockets in the amplifier rear panel and to the car lights switch, in order to light it up.

Install VCR01/VCRA/VCRD adjusters in a place you can easily and comfortably reach, according to the following connection diagram.

